

Controllable Lighting

Fluorescent Energy Management / Dimming Ballasts and Controls

The effective dimming of fluorescent lights delivers a wide range of benefits: greater control of workspace lighting, ability to create a mood, energy savings, and more.

Universal Lighting Technologies (“Universal”) line of electronic dimming ballasts and controls lets you accomplish these goals with a variety of products to suit your dimming needs. From light level switching and analog dimming to digital dimming and controls, Universal has the products and technologies to meet today’s dimming requirements for energy savings and controllable lighting.

Product Overview

Universal offers five different families of dimming products that can be used for today's dimming requirements for architectural lighting control and energy management applications:

BallaStar: Step-dimming

SuperDim: Analog (0 to 10 volt) dimming

DaliPRO: Digital dimming with the DALI protocol

VariPRO: Parallel-lamp analog dimming

LevelPRO: Parallel-lamp step dimming

BallaStar® Light Level Switching (S30 & S50)

Our Ballastar® line offers two options of light level switching (either 100/50% or 100/60/30%). That makes Ballastar® a cost-effective solution for both new construction and retrofits.

Universal Ballastar® ballasts are designed to ensure optimum lamp performance. Their Lamp Current Crest Factors are well below the maximum 1.7 ANSI standard — and they start the lamps according to ANSI recommendations at all dimming levels. Both of these important design parameters ensure optimum lamp performance. In addition, Ballastar® ballasts actually increase cathode heating when dimming to maintain the cathode's proper temperature, which enhances lamp life and performance stability.

- 1, 2, & 3 lamp models for 120 & 277 volt
- Switches to preset light levels, keeping all lamps illuminated
- Eliminates the dark spots associated with inboard/outboard configurations
- Connects with two line voltage power leads
 - Wires the same as an inboard/outboard fixture
 - No special controls required; uses two wall switches
- Meets all ASHRAE 90.1 and California Title 24 requirements for lighting control
- THD <10%
- Lower installed costs; less wiring and equipment required

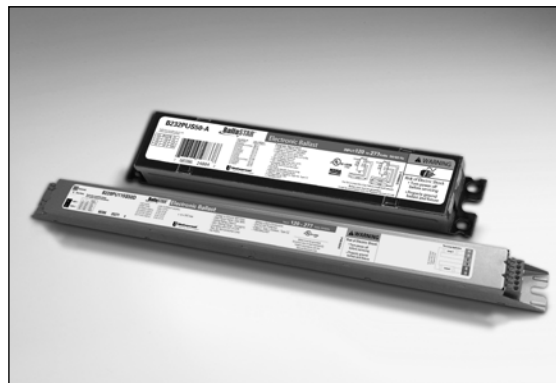

Ballastar® Light Level Switching for ultimate control.

Product Overview

SuperDim® Analog Dimming Ballasts

Universal Lighting's new SuperDim® analog dimming ballasts are a cost-effective choice for large scale dimming applications. SuperDim® ballasts are designed for T8 and T5 linear fluorescent lamps and T4 4-pin quad and triple compact fluorescent lamps.

SuperDim® ballasts are compatible with a wide range of 0 – 10 volt controls and can be connected to photocells for daylight harvesting. The resulting energy savings makes it easy to adhere to even the strictest energy requirements, including California Title 24 and ASHRAE 90.1.

These versatile ballasts offer programmed rapid start technology for longer lamp life. They also incorporate end-of-lamp-life shutdown circuits, low profile designs and < 10% THD at full bright.

Features and Benefits

- Ideal for T8 and T5 linear fluorescent lamps and T4 4-pin quad and triple compact fluorescent lamps
- Compatible with most 0 – 10 volt manufactured controls
- Daylight harvesting options with photocells for maximum energy savings
- Programmed rapid start technology maximizes lamp life
- Low profile design for fixture design flexibility
- End-of-lamp-life shutdown circuitry ensures safe operation
- < 10% THD at full bright
- Universal input voltage (120–277 volts) for installation flexibility

Product Overview

DaliPRO™ Digital Dimming Ballasts for DALI

DaliPRO™ ballasts from Universal Lighting let you take full advantage of the Digital Addressable Lighting Interface (DALI) standard...and that means greater flexibility, greater savings.

The DALI Advantage

The DALI protocol uses a 2-wire control loop to communicate with up to 64 ballasts. Broadcast, group and individual addressing is used to control light levels, recall scenes and poll ballast status.

Many DALI-compatible controls are now available from established manufacturers; and new varieties are being developed daily.

DaliPRO Features and Benefits

- Available for T8, T5, T5HO and compact fluorescent lamps
- Offers status/performance data, including lamp status
- Low profile designs for easy installation in a wide variety of fixtures
- Universal input voltage (120– 277 volts)
 - Installer-friendly; ensures you have the right ballast every time
 - Reduces inventory costs and requirements
- End-of-Lamp Life Shutdown with auto reset circuitry for safe operation
- Programmed Rapid Start for long lamp life



Product Overview

VariPRO & LevelPRO Parallel-Lamp Dimming Ballasts

Universal Lighting Technologies' parallel-lamp dimming families combine new performance features with maximum energy savings. These ballasts provide parallel-lamp operation – when one lamp fails the other remains lit. This prevents fixture from going dark and simplifies troubleshooting and maintenance operations.

Performance

- Total Harmonic Distortion (THD) < 10%
- Power Factor (PF) > 10%
- NEMA Premium
- RoHS Compliant

General Features and Benefits

- **Quick Programmed Start Technology**
 - Start time less than 700ms
 - Maintains long lamp life in frequently switched applications
- **High Efficiency Operation**
 - Complies with CEE
 - Incorporates Anti-Striation circuitry
 - Designed for use with 30, 28, and 25 Watt energy saving lamps
- **True Parallel-Lamp Operation**
 - When one lamp fails, other lamps continue to operate normally
 - Simplifies fixture troubleshooting
- **Universal Input Voltage and 347 Models**



VariPRO Features and Benefits

- **Analog (0-10V) Dimming Control**
 - Compatible with industry standard 0-10V controls and photocells
 - Ideal for daylight harvesting



LevelPRO Features and Benefits

- **Line Voltage Step Dimming Control**
 - Uses standard wall switches
 - Provides even fixture illumination

Application And Operating Information

Although dimming ballasts follow similar installation and operating guidelines as electronic ballasts, application notes and other training materials, written specifically for dimming ballasts, are provided on www.unvlt.com website.

SAFETY

Analog dimming ballasts are controlled by using a low voltage 0-10VDC control circuit. Care should be taken to insure that the line voltage (AC) wires are not connected to the low voltage DC wires. SuperDim[®] Electronic dimming ballasts have a protection circuit that will sense if the ballast has been connected in this manner and not harm the ballast.

Light Level Switching Installation Note

The two power leads for the light level switching ballasts must be connected to the same power circuit. The leads should connect to separate switches or relays for control of the light level switching operation. Connection of the input leads to separate power circuits can damage the ballasts.

Note:

Do not connect any other ballast to the load side of the switches controlling the switched dimming ballast.

Compatible Dimming Controls

For a listing of compatible controls for universal analog ballasts, please consult catalog page 2-15, or call 1-800-225-5278 or check out the Dimming and Controls section of our home page at www.unvlt.com.

Fusing

Class P ballasts do not require fusing. Fusing can be used when a single circuit has a large number of fixtures/ballasts. For a comprehensive list of appropriate fuses, contact our Technical Engineering Services (TES) Department at 1-800-225-5278.

Detailed Operating Instructions

For additional information on all of Universal's dimming products, consult our website at www.unvlt.com. Application notes, dimming brochures and online training is available

Controls For Analog Dimming Ballasts

Manual Controls, Photo-Sensors, Wall Stations & Hand Held Remotes

Manufacturer	Website	Telephone
Cooper Controls	www.coopercontrol.com	(800) 553-3879
DimOnOff	www.dimonoff.com	(418) 682-3636
Douglas Lighting Controls, Inc	www.douglaslightingcontrol.com	(604) 873-2797
HUNT Dimming	www.huntdimming.com	(970) 484-9048
Lehigh Electric Products Co.	www.lehighdim.com	(610) 395-3386
Leviton	www.leviton.com/les	1-800-736-6682
Lutron	www.lutron.com/universal	(888) LUTRON1 - Sales (800) 523-9466 - Technical Support
NexLight	www.nexlight.com	(218) 828-3700
The Watt Stopper, Inc	www.wattstopper.com	(800) 879-8585
Marlin Controls	www.marlincontrols.com	(800) 788-5750
Sensor Switch, Inc.	www.sensorswitch.com	(800) 727-7483 (800) PASSIVE
Touch-Plate Lighting Controls	www.touchplate.com	(260) 426-1565

Occupancy Sensors

Manufacturer	Website	Telephone
Cooper Controls	www.coopercontrol.com	(800) 553-3879
DimOnOff	www.dimonoff.com	(418) 682-3636
Douglas Lighting Controls, Inc	www.douglaslightingcontrol.com	(604) 873-2797
Lehigh Electric Products Co.	www.lehighdim.com	(610) 395-3386
Lutron	www.lutron.com/universal	(888) LUTRON1 - Sales (800) 523-9466 - Technical Support
NexLight	www.nexlight.com	(218) 828-3700
Marlin Controls	www.marlincontrols.com	(800) 788-5750
Sensor Switch, Inc.	www.sensorswitch.com	(800) 727-7483 (800) PASSIVE
Touch-Plate Lighting Controls	www.touchplate.com	(260) 426-1565

Systems: Control Panels, Building Management Systems, etc

Manufacturer	Website	Telephone
DimOnOff	www.dimonoff.com	(418) 682-3636
Douglas Lighting Controls, Inc	www.douglaslightingcontrol.com	(604) 873-2797
Cooper Controls	www.coopercontrol.com	(800) 553-3879
HUNT Dimming	www.huntdimming.com	(970) 484-9048
Lehigh Electric Products Co.	www.lehighdim.com	(610) 395-3386
Leviton	www.leviton.com/les	1-800-736-6682
Lutron	www.lutron.com/universal	(888) LUTRON1 - Sales (800) 523-9466 - Technical Support
NexLight	www.nexlight.com	(218) 828-3700
The Watt Stopper, Inc	www.wattstopper.com	(800) 879-8585
Marlin Controls	www.marlincontrols.com	(800) 788-5750
Touch-Plate Lighting Controls	www.touchplate.com	(260) 426-1565



The information listed above is provided by Universal Lighting Technologies to facilitate development of dimming systems. All information has been provided by the controls manufacturers, and Universal Lighting Technologies makes no guarantee regarding its accuracy. The reader is advised to contact these, and other manufacturers of analog dimming systems, to obtain application advice, to determine availability of the controls listed above, and to learn about other controls that may be offered.

Data is subject to change without notice.

Qty.	Lamp Starting Method	Line Volts	Catalog Number	Input Current (Amps)	Input Power (Watts)	Power Factor (PF)	Ballast Factor (BF)	Ballast Efficacy Factor (BEF)	THD %	Min. F/C Start Temp	Wiring Diag	Dim.
F1728												
1	PRS	120 277	B132PUNVDV3-A	0.18 0.08	21 20	>.95	1.02	5.10	<10%	32/0	1	-A
2	PRS	120 277	B232PUNVDV3-A	0.33 0.14	38 38	>.98	1.01	2.69	<10%	32/0	2	-A
F32T8 *												
1	PRS	120 277	B132PUNVDV3-A	0.30 0.13	35 35	>.95	1.00	2.90	<10%	32/0	1	-A
2	PRS	120 277	B232PUNVDV3-A	0.58 0.25	67 66	>.98	1.00	1.52	<10%	32/0	2	-A
F14T5												
1	PRS	120 277	B114PUNVDV3-D	0.15 0.07	18 18	>.95	1.00	5.61	<10%	50/10	1	-D
2	PRS	120 277	B214PUNVDV3-D	0.28 0.13	33 33	>.95	1.00	3.02	<10%	50/10	2	-D
F21T5												
1	PRS	120 277	B128PUNVDV3-D	0.23 0.10	25 24	>.95	1.00	4.15	<10%	50/10	1	-D
2	PRS	120 277	B228PUNVDV3-D	0.40 0.17	45 45	>.95	1.00	3.02	<10%	50/10	2	-D
F28T5 *												
1	PRS	120 277	B128PUNVDV3-D	0.29 0.13	32 32	>.95	1.00	3.13	<10%	50/10	1	-D
2	PRS	120 277	B228PUNVDV3-D	0.52 0.22	62 61	>.95	1.00	1.64	<10%	50/10	2	-D
F54T5HO*												
1	PRS	120 277	B254PUDV3PLD	0.51 0.23	54 56	>.97	1.00		<10%	32/0	20	-D
2	PRS	120 277	B254PUDV3PLD	0.94 0.41	116 112	>.99	1.00		<10%	32/0	2	-D
CFQ13W/G24q												
1	PRS	120 277	C213UNVDV3ME	0.15 0.07	18 18	>.90	1.00	5.56	<15%	32/0	3	-ME
2	PRS	120 277	C213UNVDV3ME	0.27 0.12	32 32	>.95	1.00	3.17	<15%	32/0	4	-ME
CFQ18W/G24q												
1	PRS	120 277	C218UNVDV3ME	0.20 0.09	23 22	>.90	1.00	4.55	<10%	32/0	3	-ME
2	PRS	120 277	C218UNVDV3ME	0.35 0.15	45 43	>.95	1.00	2.36	<10%	32/0	4	-ME
CFQ26W/G24q												
1	PRS	120 277	C226UNVDV3ME	0.25 0.11	31 29	>.95	1.00	2.00	<10%	32/0	3	-ME
2	PRS	120 277	C226UNVDV3ME	0.44 0.19	51 50	>.95	1.00	3.52	<10%	32/0	4	-ME
CFTR32W/G24q												
1	PRS	120 277	C226UNVDV3ME	0.26 0.12	32 33	>.95	1.00	3.10	<10%	32/0	3	-ME
CFTR42W/G24q												
1	PRS	120 277	C226UNVDV3ME	0.43 0.19	47 45	>.95	1.00	2.13 2.22	<10%	0/-18	3	DP2

* Consult Specification Sheets at www.unvlt.com for additional lamp applications

STARTING METHOD LEGEND
PAR-PRS = Parallel Programmed Start

See page 2-22 for Dimensions and Wiring Diagrams

SuperDim® 0-10V DIMMING BALLASTS

Please visit www.unvlt.com for the most up to date status and recent changes to the SuperDim product family.

SuperDim®

0-10V
DIMMING

Lamp		Line Volts	Catalog Number	Line Current (Amps)	Input Power (Watts)	Power Factor (PF)	Ballast Factor (BF)	THD %	Min. F/C Start Temp	Wiring Diag.	Dim.
Qty.	Starting Method										
F17T8											
1	PRS	120 277	B132PUNVSV3-A	0.13 0.06	16 16	> .97	0.85	<10	50/10	7	-A
2	PRS	120 277	B232PUNVSV3-A	0.27 0.12	32 32	> .98	0.85	<10	50/10	8	-A
F25T8											
1	PRS	120 277	B132PUNVSV3-A	0.18 0.08	22 22	> .98	0.85	<10	50/10	7	-A
2	PRS	120 277	B232PUNVSV3-A	0.38 0.16	45 44	> .99	0.85	<10	50/10	8	-A
F32T8											
1	PRS	120 277	B132PUNVSV3-A	0.25 0.11	30 30	> .99	0.88	<10	50/10	7	-A
2	PRS	120 277	B232PUNVSV3-A	0.48 0.20	57 56	> .99	0.88	<10	50/10	8	-A
F14T5											
1	PRS	120 277	B114PUNVSV3-D	0.14 0.06	17 17	> .97	1.00	<10	32/0	7	-D
2	PRS	120 277	B214PUNVSV3-D	0.27 0.11	32 32	> .97	1.00	<10	32/0	8	-D
F21T5											
1	PRS	120 277	B128PUNVSV3-D	0.27 0.12	25 25	> .95	1.01	<10	50/10	7	-D
2	PRS	120 277	B228PUNVSV3-D	0.39 0.17	47 46	> .95	1.01	<10	50/10	8	-D
F28T5											
1	PRS	120 277	B128PUNVSV3-D	0.21 0.10	32 32	> .99	1.00	<10	50/10	7	-D
2	PRS	120 277	B228PUNVSV3-D	0.53 0.22	63 61	> .99	1.00	<10	50/10	8	-D
F35T5											
1	PRS	120 277	B135PUNVSV3-D	0.33 0.14	40 39	> .99	1.00	<10	50/10	7	-D
CFQ13W/G24q & CFTR13W/Gx24q											
1	PRS	120 277	C213UNVSV3ME	0.13 0.06	16 30	> .99	1.00	<15	32/0	9	C11
2	PRS	120 277	C213UNVSV3ME	0.25 0.11	16 30	> .99	1.00	<10	32/0	10	C11
CFQ18W/G24q & CFTR18W/Gx24q											
1	PRS	120 277	C218UNVSV3ME	0.17 0.08	20 20	> .99	1.00	<10	32/0	9	C11
2	PRS	120 277	C218UNVSV3ME	0.33 0.15	39 38	> .99	1.00	<10	32/0	10	C11
CFQ26W/G24q & CFTR26W/Gx24q											
1	PRS	120 277	C226UNVSV3ME	0.26 0.10	28 28	> .96	1.00	<10	32/0	9	C11
2	PRS	120 277	C226UNVSV3ME	0.44 0.19	53 53	> .99	1.00	<10	32/0	10	C11
CFTR32W/Gx24q											
1	PRS	120 277	C226UNVSV3ME	0.28 0.12	34 34	> .97	1.00	<10	32/0	9	C11
CFTR42W/Gx24q											
1	PRS	120 277	C226UNVSV3ME	0.35 0.15	42 42	> .98	1.00	<10	32/0	9	C11

Fluorescent Dimming

STARTING METHOD LEGEND
PRS = Programmed Rapid Start

See page 2-22 for Dimensions and Wiring Diagrams

BallaSTAR® 0-10 VOLT DIMMING BALLASTS

FOR (1), (2), (3) & (4) T8 LAMPS

Please visit www.unvlt.com for the most up to date status and recent changes to the Ballastar 0-10V product family.

- Analog Dimming
- Rapid Start
- 1, 2, 3 & 4 Lamp Applications

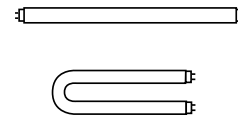

Lamp		Line Volts	Catalog Number	Line Current (Amps)	Input Power (Watts)	Power Factor (PF)	Ballast Factor (BF)	Ballast Efficacy Factor (BEF)	THD %	Min. F/C Start Temp	Wiring Diag.	Dim.
Qty.	Starting Method											
F25T8 - One Lamp Applications												
1		347	B132R347V5 @ 100%	0.08	26	> .99	0.90	3.46	< 10	50/10	7	ST
			B132R347V5 @ 5%	0.02	7	> .90	0.05	0.71	< 30	50/10	7	ST
F32T8 - One Lamp Applications												
1		347	B132R347V5 @ 100%	0.09	32	> .99	0.88	2.75	< 10	50/10	7	ST
			B132R347V5 @ 5%	0.02	8	> .90	0.05	0.63	< 20	50/10	7	ST
F32T8 - Two Lamp Applications												
2	RS	347	B232SR347V5 @ 100%	0.18	62	> .99	0.88	1.42	< 10	50/10	8	ST
			B232SR347V5 @ 5%	0.04	13	> .90	0.05	0.38	< 15	50/10	8	ST
F32T8 - Three Lamp Applications												
3	SER-RS	120	B332SR120V5 @ 100%	0.77	92	> .99	0.88	0.96	< 10	50/10	17	ST
			B332SR120V5 @ 5%	0.17	20	> .90	0.05	0.25	< 10	50/10	17	ST
		277	B332SR277V5 @ 100%	0.33	92	> .99	0.88	0.96	< 10	50/10	17	ST
			B332SR277V5 @ 5%	0.07	20	> .90	0.05	0.25	< 15	50/10	17	ST
F32T8 - Four Lamp Applications												
4	SER/PAR-RS	277	B432SR277V5 @ 100%	0.42	117	> .99	0.88	0.79	< 10	50/10	16	-ZZ
			B432SR277V5 @ 5%	0.11	27	> .90	0.05	0.19	< 15	50/10	16	-ZZ

All models except B232SR347V5 are cULus Listed
B232SR347V5 is CSA Certified

See page 2-22 for Dimensions and Wiring Diagrams

IS = Instant Start
PRS = Programmed Rapid Start
RS = Rapid Start

STARTING METHOD LEGEND
PAR-IS = Parallel Instant Start
PAR-PRS = Parallel Programmed Rapid Start

PAR-RS = Parallel Rapid Start
SER-RS = Series Rapid Start

BallaSTAR® STEP DIMMING BALLASTS

FOR (1), (2) & (3) T8 LAMPS

- Step Dimming
- Rapid Start
- 1-3 Lamp Applications

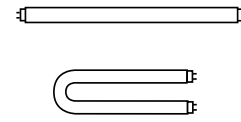

BALLASTAR

LIGHT LEVEL SWITCHING

Lamp		Line Volts	Catalog Number	Line Current (Amps)	Input Power (Watts)	Power Factor (PF)	Ballast Factor (BF)	Ballast Efficacy Factor (BEF)	THD %	Min. F/C Start Temp	Wiring Diag.	Dim.
Qty.	Starting Method											
F17T8 - One Lamp Applications												
1	PRS	120	B232PUS50-A @ 100%	0.14	16	> .95	0.88	5.50	< 15	32/0	11	-A
			B232PUS50-A @ 50%	0.08	9	> .95	0.29	3.22	< 15	32/0	11	-A
		277	B232PUS50-A @ 100%	0.08	16	> .70	0.88	5.50	< 15	32/0	11	-A
			B232PUS50-A @ 50%	0.05	9	> .70	0.29	3.22	< 15	32/0	11	-A
F17T8 - Two Lamp Applications												
2	PRS	120	B232PUS50-A @ 100%	0.25	30	> .99	0.87	2.90	< 10	32/0	12	-A
			B232PUS50-A @ 50%	0.14	16	> .98	0.30	1.88	< 15	32/0	12	-A
		277	B232PUS50-A @ 100%	0.12	30	> .88	0.87	2.90	< 10	32/0	12	-A
			B232PUS50-A @ 50%	0.07	16	> .85	0.30	1.88	< 15	32/0	12	-A
F25T8 - One Lamp Applications												
1	RS	120	B232PUS50-A @ 100%	0.21	24	> .95	0.85	3.54	< 10	32/0	11	-A
			B232PUS50-A @ 50%	0.10	12	> .90	0.28	2.33	< 10	32/0	11	-A
		277	B232PUS50-A @ 100%	0.11	24	> .80	0.85	3.54	< 10	32/0	11	-A
			B232PUS50-A @ 50%	0.06	12	> .80	0.28	2.33	< 10	32/0	11	-A
F25T8 - Two Lamp Applications												
2	SER-RS	120	B232PUS50-A @ 100%	0.39	46	> .98	0.84	1.83	< 10	32/0	12	-A
			B232PUS50-A @ 50%	0.20	24	> .95	0.28	1.17	< 10	32/0	12	-A
		277	B232PUS50-A @ 100%	0.18	46	> .98	0.84	1.83	< 10	32/0	12	-A
			B232PUS50-A @ 50%	0.09	24	> .90	0.28	1.17	< 10	32/0	12	-A
F32T8 - One Lamp Applications												
1	RS	120	B232PUS50-A @ 100%	0.25	29	> .99	0.88	3.03	< 10	32/0	11	-A
			B232PUS50-A @ 50%	0.12	14	> .98	0.29	2.07	< 10	32/0	11	-A
		277	B232PUS50-A @ 100%	0.12	29	> .85	0.88	3.03	< 10	32/0	11	-A
			B232PUS50-A @ 50%	0.06	14	> .80	0.29	2.07	< 20	32/0	11	-A
F32T8 - Two Lamp Applications												
2	SER-RS	120	B232SR120S30 @ 100%	0.52	62	> .99	0.88	1.42	< 10	50/10	12	ST
			B232SR120S30 @ 60%	0.38	45	> .95	0.58	1.29	< 10	50/10	12	ST
			B232SR120S30 @ 30%	0.24	28	> .95	0.27	0.96	< 10	50/10	12	ST
			B232SR277S30 @ 100%	0.23	62	> .99	0.88	1.42	< 10	50/10	12	ST
			B232SR277S30 @ 60%	0.17	45	> .95	0.58	1.29	< 10	50/10	12	ST
		277	B232SR277S30 @ 30%	0.11	28	> .95	0.27	0.96	< 10	50/10	12	ST
			B232PUS50-A @ 100%	0.48	57	> .99	0.88	1.54	< 10	32/0	12	-A
			B232PUS50-A @ 50%	0.24	28	> .99	0.30	1.07	< 10	32/0	12	-A
			B232PUS50-A @ 100%	0.21	56	> .95	0.88	1.57	< 10	32/0	12	-A
			B232PUS50-A @ 50%	0.11	28	> .90	0.30	1.07	< 10	32/0	12	-A
F32T8 - Three Lamp Applications												
3	SER-RS	120	B332SR120S30 @ 100%	0.78	93	> .99	0.88	0.95	< 10	50/10	15	ST
			B332SR120S30 @ 60%	0.61	69	> .95	0.60	0.87	< 10	50/10	15	ST
			B332SR120S30 @ 30%	0.40	43	> .95	0.30	0.70	< 10	50/10	15	ST
		277	B332SR277S30 @ 100%	0.34	94	> .99	0.88	0.94	< 10	50/10	15	ST
			B332SR277S30 @ 60%	0.26	69	> .95	0.60	0.87	< 10	50/10	15	ST
			B332SR277S30 @ 30%	0.16	43	> .95	0.30	0.70	< 10	50/10	15	ST

All models are cULus Listed

See page 2-22 for Dimensions and Wiring Diagrams

Fluorescent Dimming

BallaSTAR® STEP DIMMING BALLASTS FOR T5 LAMPS

- Step Dimming
- Programmed Rapid Start
- 2 Lamp Applications

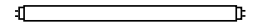

Lamp		Line Volts	Catalog Number	Line Current (Amps)	Input Power (Watts)	Power Factor (PF)	Ballast Factor (BF)	Ballast Efficacy Factor (BEF)	THD %	Min. F/C Start Temp	Wiring Diag.	Dim.
Qty.	Starting Method											
F14T5 - Lamp Applications												
1	PRS	120	B214PU115S50A @ 100%	0.17	21	> .95	1.19	5.90	< 15	50/10	11	-A
			B214PU115S50A @ 50%	0.09	10	> .95	0.40	3.74	< 15	50/10	11	-A
		277	B214PU115S50A @ 100%	0.09	21	> .75	1.19	5.80	< 15	50/10	11	-A
			B214PU115S50A @ 50%	0.05	10	> .75	0.40	3.50	< 15	50/10	11	-A
2	PRS	120	B214PU115S50A @ 100%	0.33	37.5	> .95	1.15	3.10	< 10	50/10	12	-A
			B214PU115S50A @ 50%	0.15	18	> .95	0.40	2.19	< 15	50/10	12	-A
		277	B214PU115S50A @ 100%	0.15	37	> .90	1.15	3.11	< 10	50/10	12	-A
			B214PU115S50A @ 50%	0.08	19	> .85	0.40	2.14	< 15	50/10	12	-A
2	PRS	120	B228PU95S50D @ 100%	0.29	35	> .95	1.00	2.86	< 10	50/10	14	-D
			B228PU95S50D @ 50%	0.13	16	> .95	0.37	2.30	< 10	50/10	14	-D
		277	B228PU95S50D @ 100%	0.13	35	> .95	1.00	2.86	< 10	50/10	14	-D
			B228PU95S50D @ 50%	0.06	16	> .90	0.37	2.29	< 10	50/10	14	-D
F21T5 - Lamp Applications												
1	PRS	120	B214PU115S50A @ 100%	0.24	29	> .95	1.18	4.09	< 10	50/10	11	-A
			B214PU115S50A @ 50%	0.12	14	> .95	0.39	2.84	< 15	50/10	11	-A
		277	B214PU115S50A @ 100%	0.12	29	> .85	1.18	4.06	< 15	50/10	11	-A
			B214PU115S50A @ 50%	0.62	14	> .85	0.40	2.75	< 15	50/10	11	-A
2	PRS	120	B228PU95S50D @ 100%	0.40	48	> .95	0.99	2.06	< 10	50/10	14	-D
			B228PU95S50D @ 50%	0.18	21	> .95	0.36	1.73	< 10	50/10	14	-D
		277	B228PU95S50D @ 100%	0.17	47	> .95	0.99	2.10	< 10	50/10	14	-D
			B228PU95S50D @ 50%	0.08	22	> .95	0.36	1.65	< 10	50/10	14	-D
F28T5 - Lamp Applications												
1	PRS	120	B214PU115S50A @ 100%	0.32	38	> .95	1.15	3.02	< 10	50/10	11	-A
			B214PU115S50A @ 50%	0.16	19	> .95	0.45	2.37	< 15			
		277	B214PU115S50A @ 100%	0.15	38	> .90	1.15	3.07	< 10	50/10	11	-A
			B214PU115S50A @ 50%	0.08	19	> .85	0.43	2.23	< 15			
2	PRS	120	B228PU95S50D @ 100%	0.50	58	> .99	0.95	1.64	< 10	50/10	14	-D
			B228PU95S50D @ 50%	0.23	28	> .99	0.35	1.25	< 20			
		277	B228PU95S50D @ 100%	0.21	57	> .98	0.95	1.67	< 10	50/10	14	-D
			B228PU95S50D @ 50%	0.10	28	> .95	0.35	1.25	< 20			
2	PRS	120	B228PU115S50D @ 100%	0.59	71	> .99	1.15	1.62	< 10	50/10	14	-D
			B228PU115S50D @ 50%	0.29	34	> .99	0.45	1.32	< 10			
		277	B228PU115S50D @ 100%	0.25	69	> .98	1.15	1.67	< 10	50/10	14	-D
			B228PU115S50D @ 50%	0.12	34	> .95	0.45	1.32	< 15			

° Preliminary Data

See page 2-22 for Dimensions and Wiring Diagrams

All models are cULus Listed

STARTING METHOD LEGEND

IS = Instant Start
 PRS = Programmed Rapid Start
 RS = Rapid Start

PAR-IS = Parallel Instant Start
 PAR-PRS = Parallel Programmed Rapid Start

PAR-RS = Parallel Rapid Start
 SER-RS = Series Rapid Start

Overall Dimensions		Mounting Dimensions			
Draw #	L	W	H	M	X
-A	9.50"	1.70"	1.18"	8.89"	—
-D	16.88"	1.18"	1.00"	16.20"	—
-C11	4.94"	3.00"	1.00"	4.61"	—
ST	9.50"	2.40"	1.55"	8.89"	1.69"
-ZZ	16.40"	2.40"	1.50"	15.88"	1.69"
DP1	18.00"	1.18"	1.18"	17.70"	—
DP2	4.95"	2.93"	1.38"	4.57"	—

Note: Nominal dimensions provided above
Contact Universal for drawings and/or tolerances

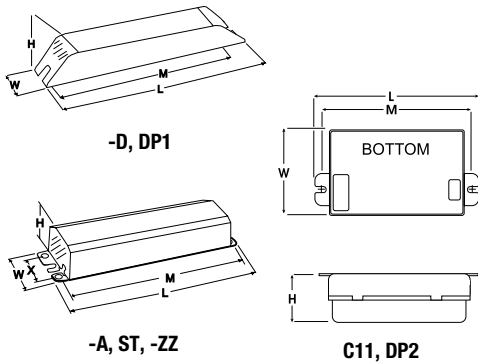

WIRING DIAGRAMS

Ballast case must be grounded. A star washer or other paint penetrating device is required

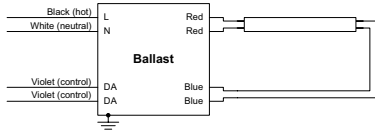

DIAGRAM 1

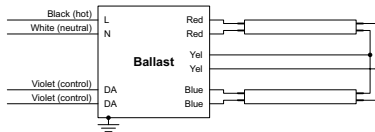

DIAGRAM 2

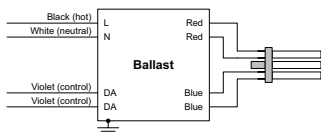

DIAGRAM 3

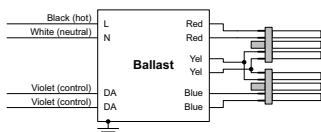

DIAGRAM 4

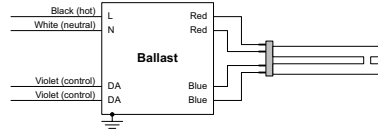

DIAGRAM 5

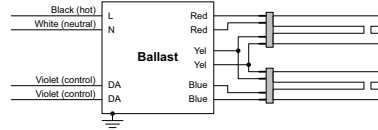

DIAGRAM 6

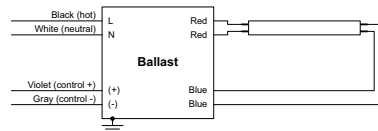

DIAGRAM 7

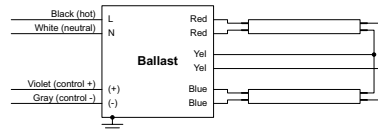

DIAGRAM 8

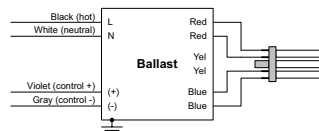

DIAGRAM 9

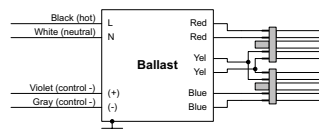

DIAGRAM 10

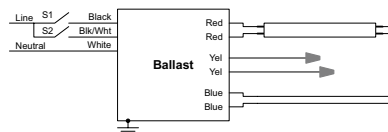

DIAGRAM 11

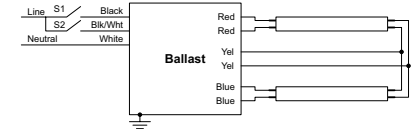

DIAGRAM 12

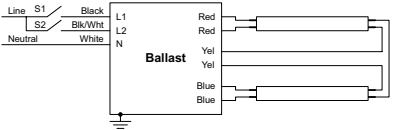

DIAGRAM 14

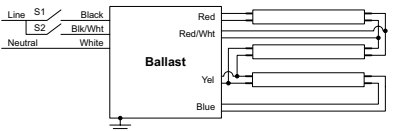

DIAGRAM 15

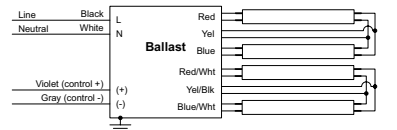

DIAGRAM 16

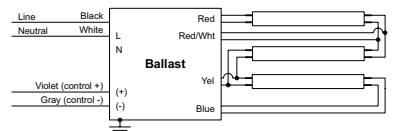

DIAGRAM 17

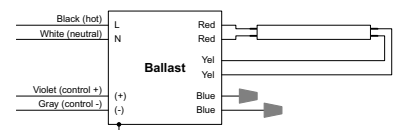

DIAGRAM 18

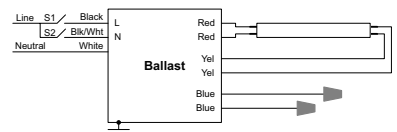

DIAGRAM 19

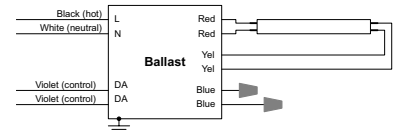

DIAGRAM 20

Lamp Qty.	Starting Method	Line Volts	Catalog Number	Line Current (Amps)	Input Power (Watts)	Power Factor (PF)	Ballast Factor (BF)	THD %	Min. F/C Start Temp ¹	Wiring Diag.	Dim.
F17T8											
1	PRS	120	B232PUSV3PLA	0.15	17	0.90	0.87	< 19	32/0	18	-A
		277	B232PUSV3PLA	0.07	17						
		347	B232P3SV3PLA	0.06	17						
2	PRS	120	B232PUSV3PLA	0.27	32	0.96	0.87	< 12	32/0	8	-A
		277	B232PUSV3PLA	0.11	31						
		347	B232P3SV3PLA	0.09	31						
F25T8											
1	PRS	120	B232PUSV3PLA	0.15	24	0.94	0.87	< 15	32/0	18	-A
		277	B232PUSV3PLA	0.09	23						
		347	B232P3SV3PLA	0.07	23						
2	PRS	120	B232PUSV3PLA	0.36	45	0.98	0.87	< 10	32/0	8	-A
		277	B232PUSV3PLA	0.15	44						
		347	B232P3SV3PLA	0.12	44						
F32T8											
1	PRS	120	B232PUSV3PLA	0.26	31	0.96	0.88	< 12	32/0	18	-A
		277	B232PUSV3PLA	0.11	30						
		347	B232P3SV3PLA	0.09	30						
2	PRS	120	B232PUSV3PLA	0.48	57	0.98	0.87	< 10	32/0	8	-A
		277	B232PUSV3PLA	0.21	57						
		347	B232P3SV3PLA	0.16	57						
F40T8											
1	PRS	120	B232PUSV3PLA	0.31	38	0.97	0.87	< 10	32/0	18	-A
		277	B232PUSV3PLA	0.13	37						
		347	B232P3SV3PLA	0.11	37						
2	PRS	120	B232PUSV3PLA	0.59	71	0.99	0.87	< 10	32/0	8	-A
		277	B232PUSV3PLA	0.25	70						
		347	B232P3SV3PLA	0.20	70						
F32T8 (30W)											
1	PRS	120	B232PUSV3PLA	0.25	30	0.95	0.87	< 12	60/15	18	-A
		277	B232PUSV3PLA	0.11	29						
		347	B232P3SV3PLA	0.09	29						
2	PRS	120	B232PUSV3PLA	0.46	55	0.98	0.87	< 10	60/15	8	-A
		277	B232PUSV3PLA	0.19	54						
		347	B232P3SV3PLA	0.16	54						
F28T8											
1	PRS	120	B232PUSV3PLA	0.22	26	0.94	0.87	< 14	60/15	18	-A
		277	B232PUSV3PLA	0.09	26						
		347	B232P3SV3PLA	0.09	26						
2	PRS	120	B232PUSV3PLA	0.40	49	0.98	0.87	< 10	60/15	8	-A
		277	B232PUSV3PLA	0.17	48						
		347	B232P3SV3PLA	0.14	48						
F30T8 (25W)											
1	PRS	120	B232PUSV3PLA	0.20	24	0.94	0.87	< 15	60/15	18	-A
		277	B232PUSV3PLA	0.09	23						
		347	B232P3SV3PLA	0.07	23						
2	PRS	120	B232PUSV3PLA	0.37	45	0.98	0.87	< 10	60/15	8	-A
		277	B232PUSV3PLA	0.16	44						
		347	B232P3SV3PLA	0.13	44						

¹ A short stabilization period may be needed for temperatures below 10C

See page 2-22 for Dimensions
and Wiring Diagrams

VariPRO DIMMING BALLASTS

PARALLEL LAMP

VariPRO

0-10V
DIMMING
T5

Lamp Qty.	Starting Method	Line Volts	Catalog Number	Line Current (Amps)	Input Power (Watts)	Power Factor (PF)	Ballast Factor (BF)	THD %	Min. F/C Start Temp ¹	Wiring Diag.	Dim.
F14T5											
1	PRS	120	B228PUSV3PLA	0.17	19	0.93	1.00	< 17	50/10	18	-A
		277	B228PUSV3PLA	0.07	18						
		347	B228P3SV3PLA	0.06	19						
2	PRS	120	B228PUSV3PLA	0.30	34	0.97	1.00	< 10	50/10	8	-A
		277	B228PUSV3PLA	0.13	33						
		347	B228P3SV3PLA	0.11	34						
F21T5											
1	PRS	120	B228PUSV3PLA	0.23	26	0.95	1.00	< 13	50/10	18	-A
		277	B228PUSV3PLA	0.10	25						
		347	B228P3SV3PLA	0.09	26						
2	PRS	120	B228PUSV3PLA	0.42	48	0.98	1.00	< 10	50/10	8	-A
		277	B228PUSV3PLA	0.18	47						
		347	B228P3SV3PLA	0.15	47						
F28T5											
1	PRS	120	B228PUSV3PLA	0.29	33	0.97	1.00	< 10	50/10	18	-A
		277	B228PUSV3PLA	0.13	33						
		347	B228P3SV3PLA	0.11	34						
2	PRS	120	B228PUSV3PLA	0.56	64	0.99	1.00	< 10	50/10	8	-A
		277	B228PUSV3PLA	0.24	63						
		347	B228P3SV3PLA	0.19	63						
F28T5ES (25W)											
1	PRS	120	B228PUSV3PLA	0.27	31	0.96	1.00	< 12	60/15	18	-A
		277	B228PUSV3PLA	0.12	31						
		347	B228P3SV3PLA	0.09	30						
2	PRS	120	B228PUSV3PLA	0.51	59	0.99	1.00	< 10	60/15	8	-A
		277	B228PUSV3PLA	0.22	57						
		347	B228P3SV3PLA	0.17	58						

¹ A short stabilization period may be needed for temperatures below 10C

See page 2-22 for Dimensions and Wiring Diagrams

Fluorescent Dimming

Lamp Qty.	Starting Method	Line Volts	Catalog Number	Line Current (Amps)	Input Power (Watts)	Power Factor (PF)	Ballast Factor (BF)	THD %	Min. F/C Start Temp ¹	Wiring Diag.	Dim.
F54T5HO											
1	PRS	120	B254PUSV3PLD	0.46	54	0.97	1.00	< 10	32/0	18	-D
		277	B254PUSV3PLD	0.21	56						
		347	B254P3SV3PLD	0.18	58						
2	PRS	120	B254PUSV3PLD	0.98	116	0.99	1.00	< 10	32/0	8	-D
		277	B254PUSV3PLD	0.42	112						
		347	B254P3SV3PLD	0.33	109						
F54T5HOES (49W)											
1	PRS	120	B254PUSV3PLD	0.44	52	0.96	1.00	< 10	60/15	18	-D
		277	B254PUSV3PLD	0.20	53						
		347	B254P3SV3PLD	0.16	54						
2	PRS	120	B254PUSV3PLD	0.86	102	0.99	1.00	< 10	60/15	8	-D
		277	B254PUSV3PLD	0.38	101						
		347	B254P3SV3PLD	0.30	101						
FT55W/2G11											
1	PRS	120	B254PUSV3PLD	0.47	58	0.97	0.90	< 10	60/15	18	-D
		277	B254PUSV3PLD	0.21	58						
		347	B254P3SV3PLD	0.17	57						
2	PRS	120	B254PUSV3PLD	0.89	109	0.99	0.90	< 10	60/15	8	-D
		277	B254PUSV3PLD	0.38	105						
		347	B254P3SV3PLD	0.31	108						
FC55T5HO											
1	PRS	120	B254PUSV3PLD	0.45	54	0.96	0.90	< 10	60/15	18	-D
		277	B254PUSV3PLD	0.19	53						
		347	B254P3SV3PLD	0.16	56						
2	PRS	120	B254PUSV3PLD	0.86	105	0.98	0.90	< 10	60/15	8	-D
		277	B254PUSV3PLD	0.37	103						
		347	B254P3SV3PLD	0.30	105						

¹ A short stabilization period may be needed for temperatures below 10C

See page 2-22 for Dimensions and Wiring Diagrams

LevelPRO DIMMING BALLASTS

PARALLEL LAMP

LevelPRO

STEP-DIMMING
HIGH BALLAST
FACTOR

Lamp		Line Volts	Catalog Number	Line Current (Amps)	Input Power (Watts)	Power Factor (PF)	Ballast Factor (BF)	THD %	Min. F/C Start Temp ¹	Wiring Diag.	Dim.
Qty.	Starting Method										
F17T8											
1	PRS	120	B232PUS50PLHA	0.19	23	0.96	1.15	< 15	32/0	19	-A
		277	B232PUS50PLHA	0.08	23						
		347	B232P3S50PLHA	0.07	22						
2	PRS	120	B232PUS50PLHA	0.35	42	0.98	1.15	< 10	32/0	12	-A
		277	B232PUS50PLHA	0.15	41						
		347	B232P3S50PLHA	0.12	41						
F25T8											
1	PRS	120	B232PUS50PLHA	0.27	32	0.97	1.15	< 10	32/0	19	-A
		277	B232PUS50PLHA	0.12	32						
		347	B232P3S50PLHA	0.09	31						
2	PRS	120	B232PUS50PLHA	0.50	60	0.99	1.15	< 10	32/0	12	-A
		277	B232PUS50PLHA	0.21	59						
		347	B232P3S50PLHA	0.17	59						
F32T8											
1	PRS	120	B232PUS50PLHA	0.34	40	0.98	1.15	< 10	32/0	19	-A
		277	B232PUS50PLHA	0.15	40						
		347	B232P3S50PLHA	0.12	39						
2	PRS	120	B232PUS50PLHA	0.64	77	0.99	1.15	< 10	32/0	12	-A
		277	B232PUS50PLHA	0.27	75						
		347	B232P3S50PLHA	0.22	75						
F32T8 (30W)											
1	PRS	120	B232PUS50PLHA	0.32	38	0.98	1.15	< 10	60/15	19	-A
		277	B232PUS50PLHA	0.14	38						
		347	B232P3S50PLHA	0.11	38						
2	PRS	120	B232PUS50PLHA	0.60	72	0.99	1.15	< 10	60/15	12	-A
		277	B232PUS50PLHA	0.25	70						
		347	B232P3S50PLHA	0.20	69						
F28T8											
1	PRS	120	B232PUS50PLHA	0.28	34	0.98	1.15	< 10	60/15	19	-A
		277	B232PUS50PLHA	0.12	33						
		347	B232P3S50PLHA	0.10	33						
2	PRS	120	B232PUS50PLHA	0.54	65	0.99	1.15	< 10	60/15	12	-A
		277	B232PUS50PLHA	0.23	63						
		347	B232P3S50PLHA	0.18	63						
F30T8 (25W)											
1	PRS	120	B232PUS50PLHA	0.27	32	0.97	1.15	< 10	60/15	19	-A
		277	B232PUS50PLHA	0.12	32						
		347	B232P3S50PLHA	0.09	31						
2	PRS	120	B232PUS50PLHA	0.50	60	0.99	1.15	< 10	60/15	12	-A
		277	B232PUS50PLHA	0.21	59						
		347	B232P3S50PLHA	0.17	59						

¹ A short stabilization period may be needed for temperatures below 10C

See page 2-22 for Dimensions
and Wiring Diagrams

Fluorescent Dimming

LevelPRO DIMMING BALLASTS

LIGHT-LEVEL SWITCHING PARALLEL LAMP

Lamp		Line Volts	Catalog Number	Line Current (Amps)	Input Power (Watts)	Power Factor (PF)	Ballast Factor (BF)	THD %	Min. F/C Start Temp ¹	Wiring Diag.	Dim.
Qty.	Starting Method										
F17T8											
1	PRS	120	B232PUS50PLA	0.15	17	0.94	0.87	< 19	32/0	19	-A
		277	B232PUS50PLA	0.06	17						
		347	B232P3S50PLA	0.05	17						
2	PRS	120	B232PUS50PLA	0.26	31	0.97	0.87	< 10	32/0	12	-A
		277	B232PUS50PLA	0.11	31						
		347	B232P3S50PLA	0.09	31						
F25T8											
1	PRS	120	B232PUS50PLA	0.21	25	0.96	0.87	< 14	32/0	19	-A
		277	B232PUS50PLA	0.09	25						
		347	B232P3S50PLA	0.07	25						
2	PRS	120	B232PUS50PLA	0.38	46	0.98	0.87	< 10	32/0	12	-A
		277	B232PUS50PLA	0.16	44						
		347	B232P3S50PLA	0.13	44						
F32T8											
1	PRS	120	B232PUS50PLA	0.26	31	0.97	0.88	< 11	32/0	19	-A
		277	B232PUS50PLA	0.11	31						
		347	B232P3S50PLA	0.09	31						
2	PRS	120	B232PUS50PLA	0.48	59	0.99	0.87	< 10	32/0	12	-A
		277	B232PUS50PLA	0.21	58						
		347	B232P3S50PLA	0.17	58						
F40T8											
1	PRS	120	B232PUS50PLA	0.32	39	0.98	0.87	< 10	32/0	19	-A
		277	B232PUS50PLA	0.14	38						
		347	B232P3S50PLA	0.11	38						
2	PRS	120	B232PUS50PLA	0.61	74	0.99	0.87	< 10	32/0	12	-A
		277	B232PUS50PLA	0.26	72						
		347	B232P3S50PLA	0.21	72						
F32T8 (30W)											
1	PRS	120	B232PUS50PLA	0.24	29	0.97	0.87	< 12	60/15	19	-A
		277	B232PUS50PLA	0.10	29						
		347	B232P3S50PLA	0.08	29						
2	PRS	120	B232PUS50PLA	0.46	56	0.99	0.87	< 10	60/15	12	-A
		277	B232PUS50PLA	0.19	54						
		347	B232P3S50PLA	0.16	54						
F28T8											
1	PRS	120	B232PUS50PLA	0.22	26	0.96	0.87	< 14	60/15	19	-A
		277	B232PUS50PLA	0.09	26						
		347	B232P3S50PLA	0.08	25						
2	PRS	120	B232PUS50PLA	0.41	49	0.99	0.87	< 10	60/15	12	-A
		277	B232PUS50PLA	0.17	48						
		347	B232P3S50PLA	0.14	48						

¹ A short stabilization period may be needed for temperatures below 10C

See page 2-22 for Dimensions and Wiring Diagrams

See page 2-20 for Dimensions and Wiring Diagrams

LevelPRO DIMMING BALLASTS

LIGHT-LEVEL SWITCHING PARALLEL LAMP

LevelPRO

STEP-DIMMING
NORMAL BALLAST
FACTOR

Lamp Qty.	Starting Method	Line Volts	Catalog Number	Line Current (Amps)	Input Power (Watts)	Power Factor (PF)	Ballast Factor (BF)	THD %	Min. F/C Start Temp ¹	Wiring Diag.	Dim.
F30T8 (25W)											
1	PRS	120	B232PUS50PLA	0.21	25	0.96	0.87	< 14	60/15	19	-A
		277	B232PUS50PLA	0.09	25						
		347	B232P3S50PLA	0.07	25						
2	PRS	120	B232PUS50PLA	0.38	46	0.98	0.87	< 10	60/15	12	-A
		277	B232PUS50PLA	0.16	44						
		347	B232P3S50PLA	0.13	44						
F14T5											
1	PRS	120	B232PUS50PLA	0.16	19	0.94	1.00	< 17	50/10	19	-A
		277	B232PUS50PLA	0.07	19						
		347	B232P3S50PLA	0.06	19						
2	PRS	120	B232PUS50PLA	0.30	34	0.98	1.00	< 10	50/10	12	-A
		277	B232PUS50PLA	0.13	34						
		347	B232P3S50PLA	0.10	34						
F21T5											
1	PRS	120	B232PUS50PLA	0.23	26	0.96	1.00	< 12	50/10	19	-A
		277	B232PUS50PLA	0.10	26						
		347	B232P3S50PLA	0.08	26						
2	PRS	120	B232PUS50PLA	0.42	49	0.99	1.00	< 10	50/10	12	-A
		277	B232PUS50PLA	0.18	48						
		347	B232P3S50PLA	0.14	48						
F28T5											
1	PRS	120	B232PUS50PLA	0.29	34	0.97	1.00	< 10	50/10	19	-A
		277	B232PUS50PLA	0.12	33						
		347	B232P3S50PLA	0.10	33						
2	PRS	120	B232PUS50PLA	0.56	65	0.99	1.00	< 10	50/10	12	-A
		277	B232PUS50PLA	0.24	63						
		347	B232P3S50PLA	0.19	63						
F28T5ES (25W)											
1	PRS	120	B232PUS50PLA	0.26	30	0.97	1.00	< 12	60/15	19	-A
		277	B232PUS50PLA	0.11	30						
		347	B232P3S50PLA	0.09	29						
2	PRS	120	B232PUS50PLA	0.51	59	0.97	1.00	< 10	60/15	12	-A
		277	B232PUS50PLA	0.25	58						
		347	B232P3S50PLA	0.17	58						

¹ A short stabilization period may be needed

See page 2-22 for Dimensions
and Wiring Diagrams

Fluorescent Dimming

*It's **EASY**
to **REACH US...***



UNIVERSAL LIGHTING TECHNOLOGIES, INC.
51 Century Blvd., Suite 230
Nashville, TN 37214-3683

GENERAL INFO: **(615) 316-5100**

For Technical Engineering Services (TES),
application support and warranty information,
call **1-800-225-5278**

WEBSITE: **unvlt.com**
EMAIL: **webmaster@unvlt.com**

LIT#: BNC070517